

# LEGEND<sup>NX</sup>

## LGNXT05DIWFB

### 5.1 MP Black Turret Network Camera, Intelligent Dual Light Fixed Lens

- 5MP High-Resolution Imaging
- Improve human and vehicle classification using deep learning
- 120 dB true WDR Technology
- Built-in microphone
- Advanced H.265+ Compression



### In short

This 5MP camera provides high-resolution imaging with advanced H.265+ compression and 120 dB true WDR technology for optimal clarity in various lighting conditions. It enhances human and vehicle classification through deep learning, and is water and dust resistant (IP67), complete with a built-in microphone.

### Dimensions

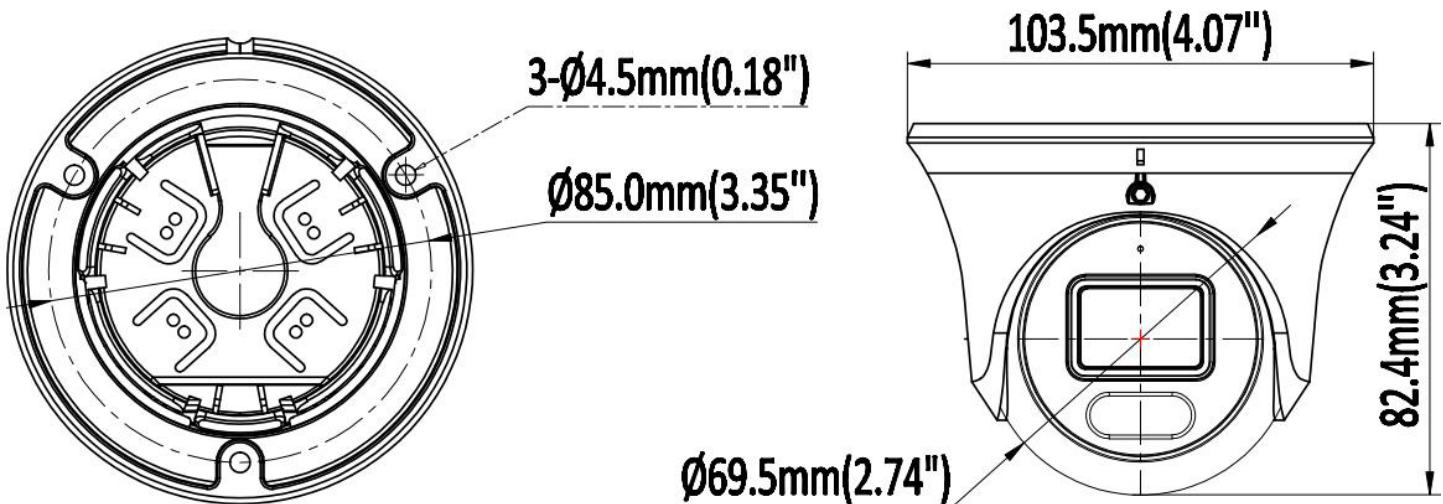

\*Design and specifications are subjects to change without notice.

## Technical Specifications

Camera: LGNXT05DIWFB	
Image Sensor	1/2.7" Progressive Scan CMOS Sensor
Minimum Illumination	Color: 0.006 Lux (F1.6 , AGC ON) , 0 Lux with light
Illumination Distance	30m / 98.43ft (IR light) 30m/98.43ft (Warm light)
Strobe Light	N/A
Smart IR	Supported
Pan / Tilt / Rotation Range	Pan: 0° ~ 360° Tilt: 0° ~ 75° Rotation: 0° ~ 360°
Lens	
Focal Length	2.8mm
Aperture	F1.6
Field of View	2.8mm: Horizontal FOV: 114°, Vertical FOV: 61°, Diagonal FOV: 135°
Lens Mount	M12
Camera Image	
Maximum Resolution	5MP (2960 × 1664)
Main Stream	50Hz: 20fps 5MP (2960 × 1664), 25fps 4MP (2688 × 1520), 25fps 4M (2560 × 1440), 25fps 1080P (1920 × 1080)
	60Hz: 20fps 5MP (2960 × 1664), 30fps 4MP (2688 × 1520), 30fps 4M (2560 × 1440), 30fps 1080P (1920 × 1080)
Sub Stream	50Hz: 25fps 720P (1280 × 720) 25fps D1 (704 × 576) , 25fps CIF (352 × 288)
	60Hz: 30fps 720P (1280 × 720) 30fps D1 (704 × 480) , 30fps CIF (352 × 240)
Third Stream	50Hz: 25fps CIF (352 × 288)
	60Hz: 30fps CIF (352 × 240)
Image Setting	Brightness / Contrast / Saturation / Hue / Sharpness
Shutter Time	Auto/Manual, 1/3 ~ 1/100000s
Day/Night	IR Cut filter
Wide Dynamic Range	120 dB
Digital Noise Reduction	2D/3D DNR
BLC	Supported
HLC	Supported
ROI	Supported
Rotate	Supported
Compression	
Video Compression	H.264 / H.264+ / H.265 / H.265+ / MJPEG (sub stream)
H.264 Codec Profile	Base / Main / High profile
H.265 Codec Profile	Main Profile
Video Bit Rate	11 Kbps ~ 10 Mbps
Triple Streams	Supported
Audio Compression	G.711A, G.711U
Audio Bit Rate	64 Kbps

\*Design and specifications are subjects to change without notice.

## Technical Specifications

Smart Features	
Basic Events	Motion detection, Video Tampering
Smart Events	Line crossing detection, area intrusion, Monitoring entry and exit for specific regions (support alarm triggering by specified target types (human and vehicle))
Face Detection	N/A
Network	
Network Storage	NAS (NFS, SMB/CIFS), ANR
Protocols	TCP/IP, ICMP, HTTP, HTTPS, FTP, DHCP, DNS, DDNS, RTP, RTSP, RTCP, NTP, IGMP, UPnP, SMTP, UPnP-TM, P2P
System Compatibility	Onvif (Profile S, Profile G, T), SDK
Security	User authentication, IP address filtering, Video mask
Users	Maximum 40 users
Web Browsers	Plug-in required live view: IE 10, IE 11 Local service: Chrome 57.0+, Firefox 52.0+
Mobile Surveillance	iOS, Android
Hardware	
Communication interface	1 RJ45 10 M/100 M self-adaptive Ethernet port
Storage	Up to 256GB
Microphone	Supported
Speaker	N/A
Audio I/O	N/A
Alarm I/O	N/A
Reset button	Supported
Active Deterrence Features	Red/Blue Light Warning
General	
Operating Conditions	-40°C ~ 60°C (-40°F ~ 140°F) Humidity 95% or less (non-condensing)
Power Supply	DC12V ± 25%
PoE	PoE (802.3 af)
Power Consumption	Less than 6W
Protection Level	IP67
Material	Metal
Dimensions	Φ 103.5 × 82.4 mm (Φ 4.07" × 3.24")
Gross Weight	0.99lb / 450g

\*Design and specifications are subjects to change without notice.

# What you may need



**XLGNXLB10B**  
Black Junction Box  
Φ112.5 mm × 49.5mm



**XLGNXPM03**  
Pole Mount  
Φ170mm × 135.8mm × 43.7mm



**XLGNXLB14CB**  
Black Wall Mount  
Φ120mm × 105.8mm x 183.5mm



**XLGNXCM700**  
Pendant Mount Bracket  
Φ116 mm × 734.5 mm

## Accessories Mount

**XLGNXLB10B**

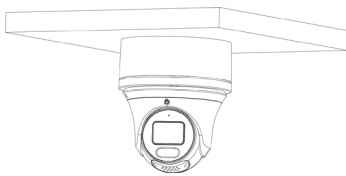

**XLGNXLB14CB**

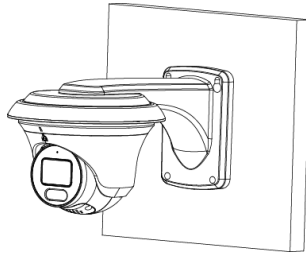

**XLGNXLB10B +  
XLGNXLB14CB**

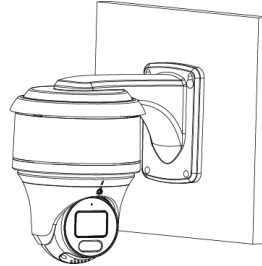

**XLGNXLB10 +  
XLGNXCM700**

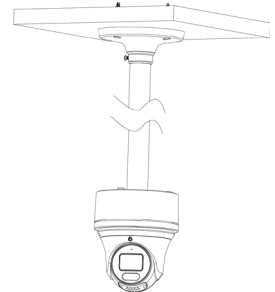

**XLGNXPM03**

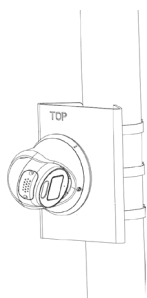

**XLGNXPM03 +  
XLGNXLB10B**

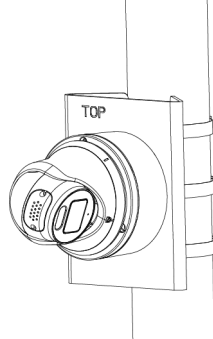

**XLGNXPM03 +  
XLGNXLB14CB**

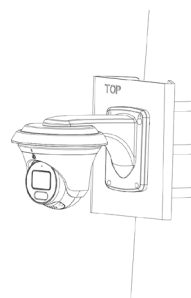

**XLGNXPM03 + XLGNXLB10B +  
XLGNXLB14CB**

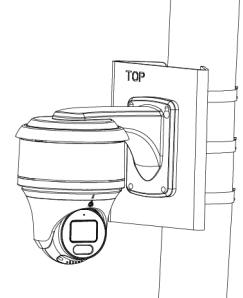

\*Design and specifications are subjects to change without notice.